

name _____

HOMEWORK LOG

Reading and Language Arts

January 12-16, 2026

Monday

Picture/Sound
Dd and Ff

Title of Book: _____

Tuesday

Letter Ff

Title of Book: _____

Wednesday

Drawing Pictures

Title of Book: _____

Thursday

Sight Word "we"

Title of Book: _____

Reminders:

*Letter of the Week: Ff

*Sight Word of the Week: we

*Weekly Theme:
Penguins/MLK

*Rhyming Words

*Name Writing-
First and Last Name

Miscellaneous:

*Letters already taught: Bb, Aa,
Tt, Pp, Ss, Mm, Oo, Cc, Rr, Ll, Uu,
Nn, Ii, Gg, Dd

*Sight Words already taught:
see, I, me, a, for, at, is, the, be,
am, like, you

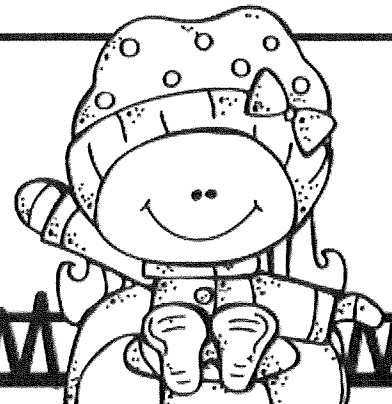

Name: _____

Picture/Sound

D d	F f

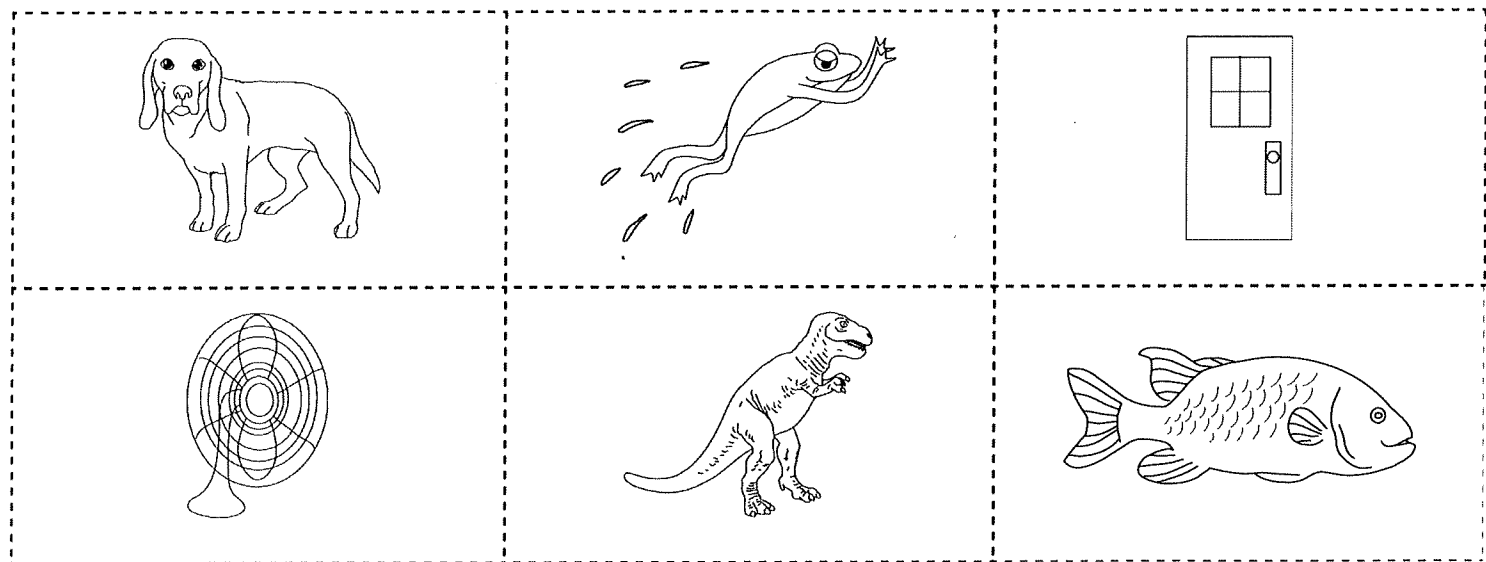

Name the pictures dog, frog, door, fan, dinosaur, fish. Listen for the sound /d/. Cut and paste the pictures beginning with /d/ in the first box and the pictures beginning with the sound /f/ in the second box.

Tuesday

Name _____

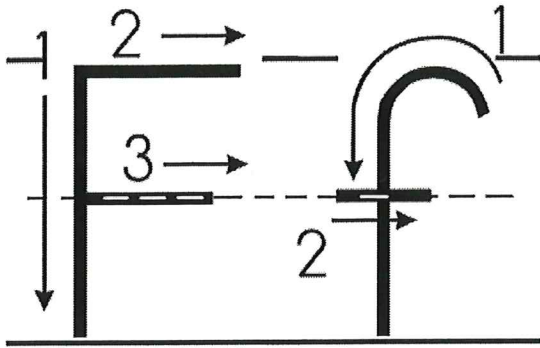

Draw a picture that begins with the letter.

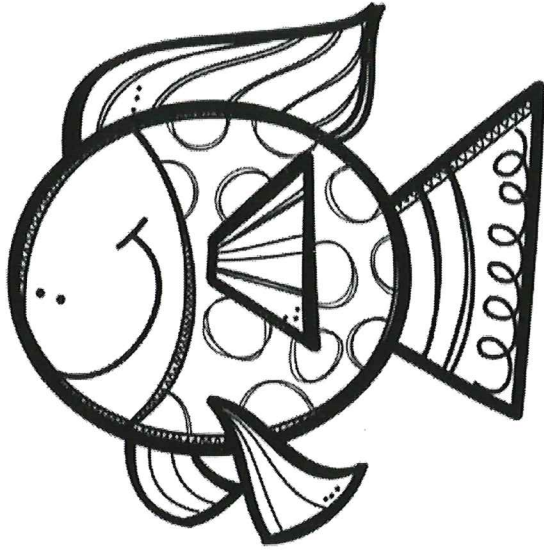

Trace the letters.

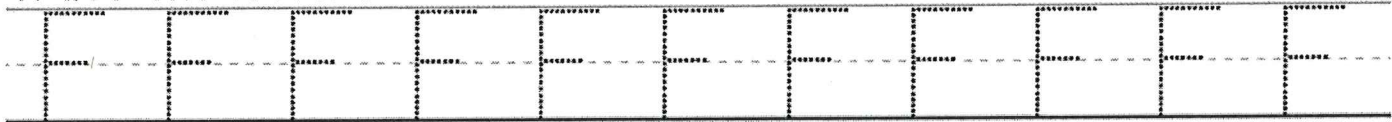

Write the letter. Start at the dot.

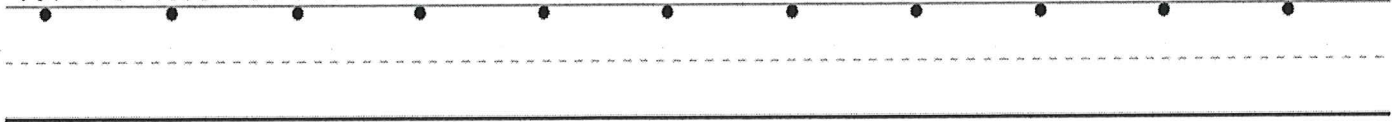

Trace the letters.

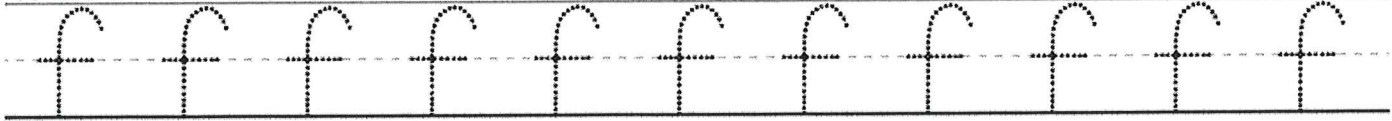

Write the letter. Start at the dot.



Name: _____

Wednesday

Draw a picture that starts with each letter. color nicely.

Bb

Rr

Ff

Ss

Name: _____

we

 Color the word.

we

we

we

 Trace the word.

we

we

we

 Box the word.

we

we

we

 Write the word.

 Build the word.

we

cut
out
letters

e w